

SCALE 2:5

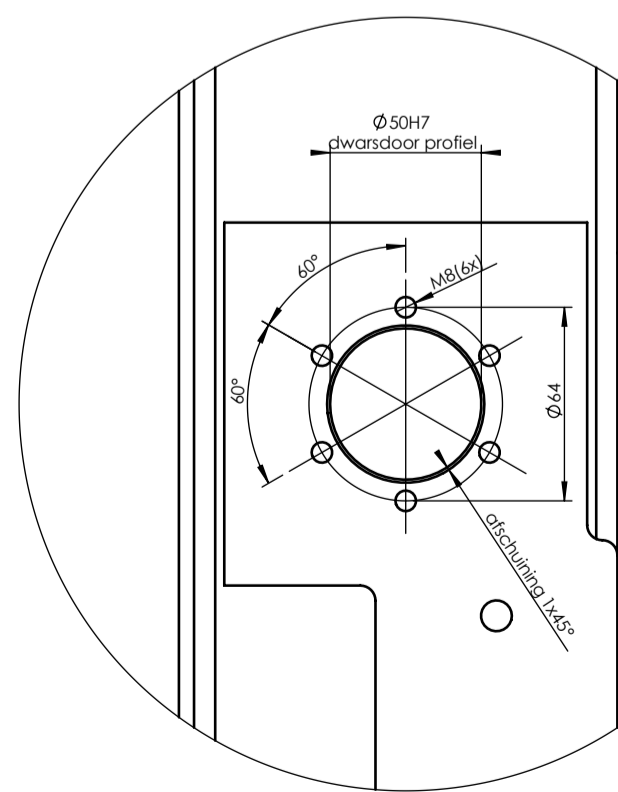

SCALE 2:5

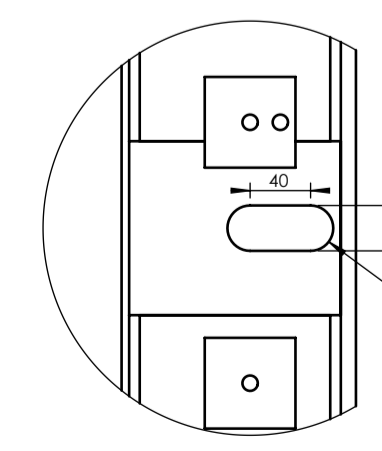
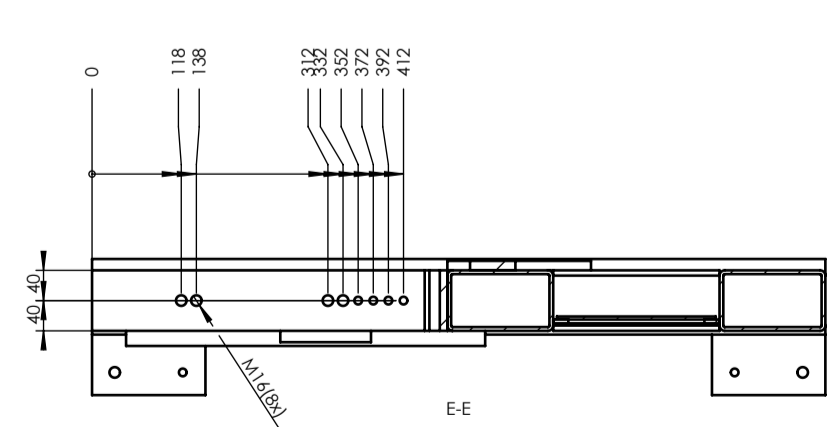
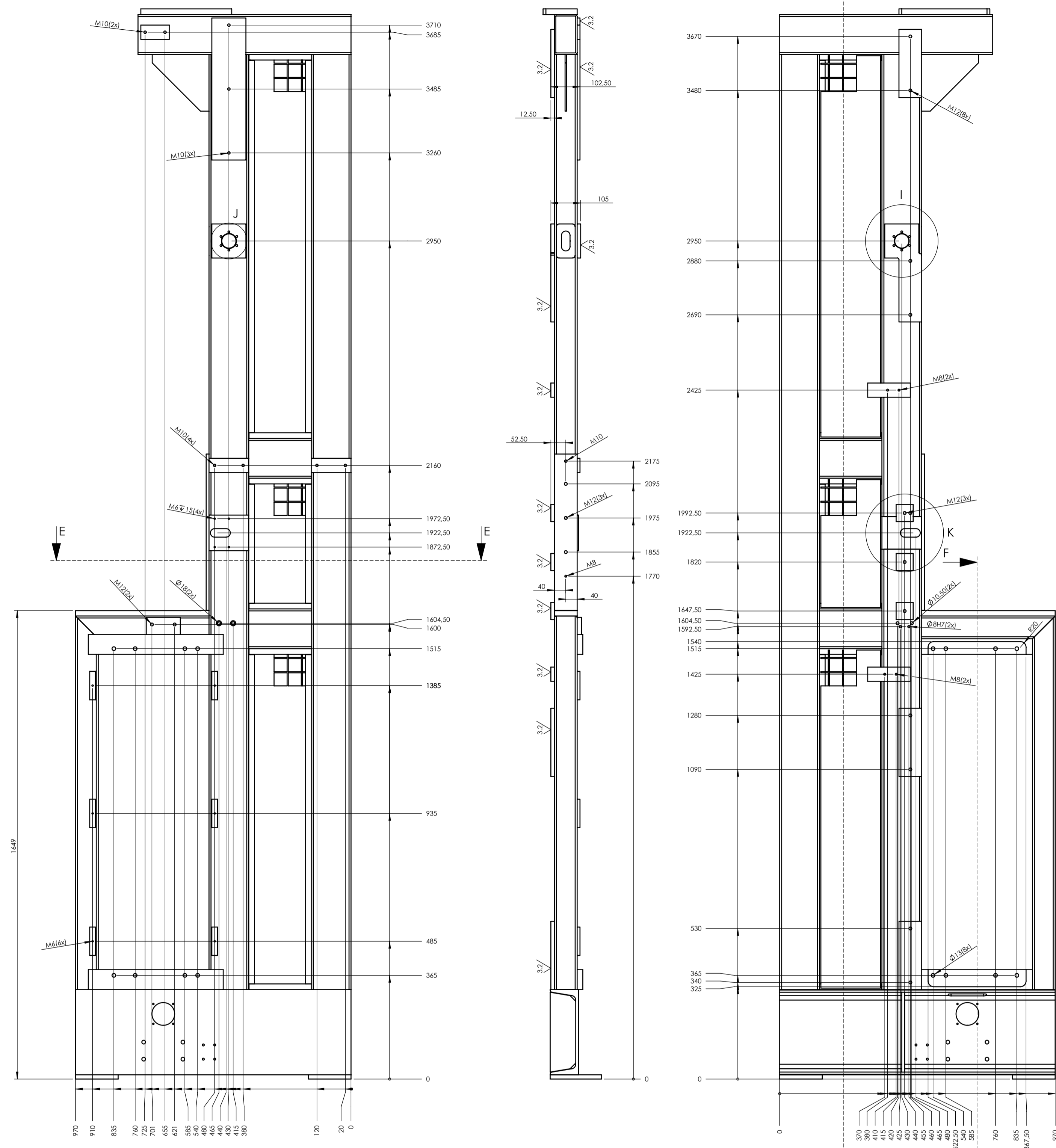

SCALE 1:5

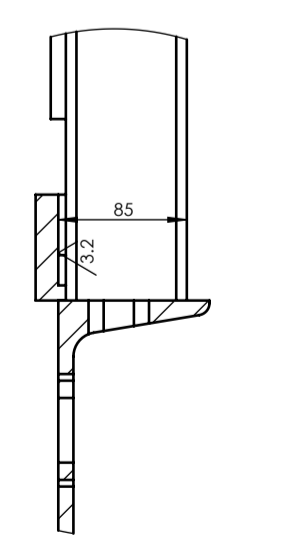
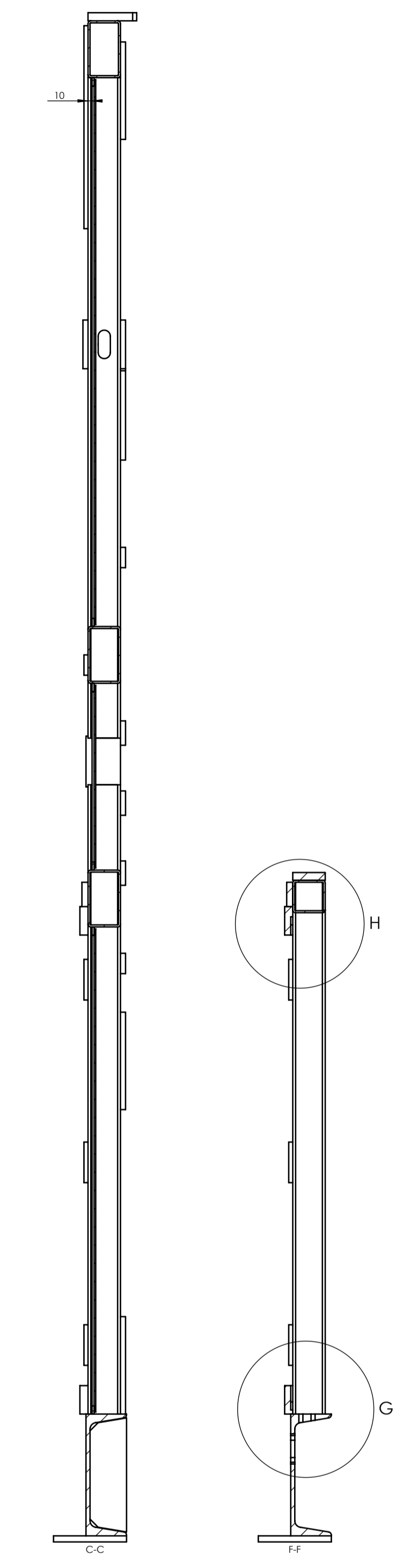

SCALE 1:5

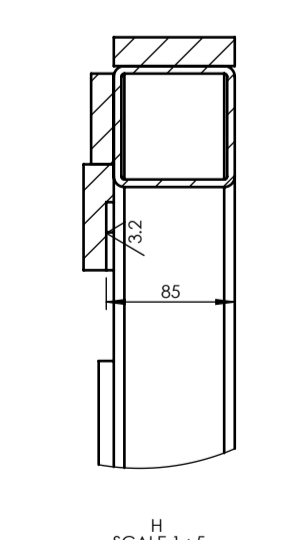

SCALE 1:5

Materiaal: zie stuklijst
linker frame lijneenheid

Logo of Alpha-tech.be
Klantreferentie: --
IT12
Algemeen vorm- en product nr.: NEN 3311
ISO 1:10
3/07/2017

Aantal: --
Tek. Nr.: 19884-2